

User Manual

Off Grid Solar Inverter 4KW-12KW

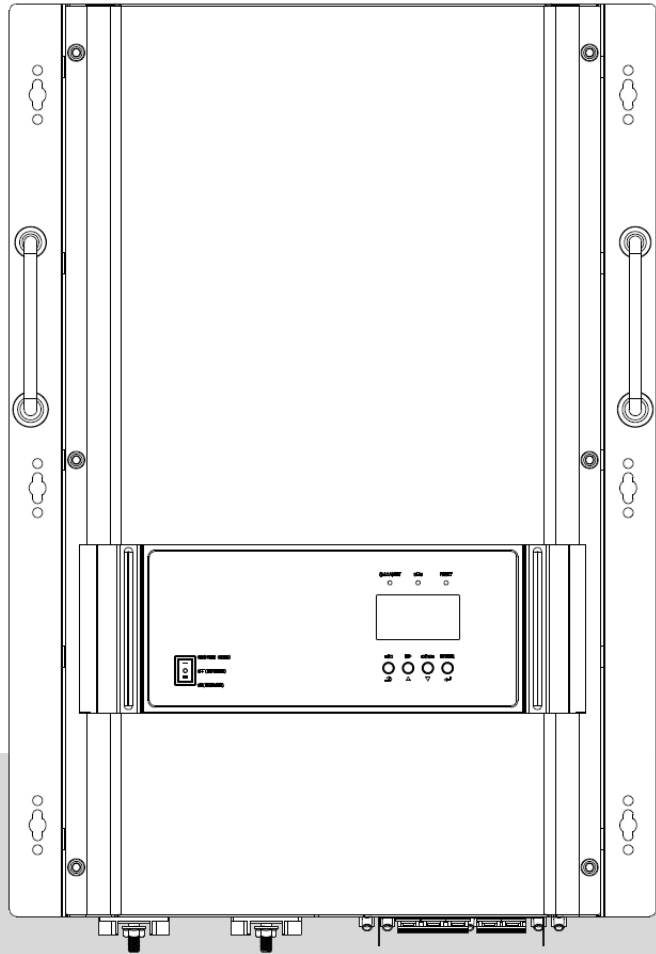

Table Of Contents

- Information on this Manual1**
 - Validity1
 - Scope.....1
 - Target Group.....1
 - Safety Instructions1
- Introduction.....2**
 - Features2
 - Product Overview3
- Installation.....4**
 - Unpacking and Inspection4
 - Preparation4
 - Mounting the Unit.....4
 - Battery Connection5
 - AC Input/Output Connection8
 - PV Connection10
 - Communication Connection11
 - Dry Contact Signal.....11
 - Electrical Performance12
- Operation15**
 - Power ON/OFF15
 - Operation and Display Panel.....15
 - LCD Display Icons.....16
 - LCD Setting.....16
 - Display Information.....23
 - Operating Mode Description26
 - Fault Reference Code.....27
 - Warning Indicator.....27
- Trouble Shooting.....28**
- Specifications29**

Information on this Manual

Validity

This manual is valid for the following devices:

- ▶ SPF 4KT HVM
- ▶ SPF 5KT HVM
- ▶ SPF 6KT HVM
- ▶ SPF 8KT HVM
- ▶ SPF 10KT HVM
- ▶ SPF 12KT HVM

Scope

This manual describes the assembly, installation, operation and troubleshooting of this unit. Please read this manual carefully before installations and operations.

Target Group

This document is intended for qualified persons and end users. Tasks that do not require any particular qualification can also be performed by end users. Qualified persons must have the following skills:

- ▶ Knowledge of how an inverter works and is operated
- ▶ Training in how to deal with the dangers and risks associated with installing and using electrical devices and installations
- ▶ Training in the installation and commissioning of electrical devices and installations
- ▶ Knowledge of the applicable standards and directives
- ▶ Knowledge of and compliance with this document and all safety information

Safety Instructions



WARNING: This chapter contains important safety and operating instructions. Read and keep this manual for future reference.

1. **CAUTION** – Only qualified personnel can install this device with battery.
2. Before using the unit, read all instructions and caution marks on the unit, understand the batteries and all appropriate sections of this manual.
3. **CAUTION** --To reduce risk of injury, charge only deep-cycle lead acid type rechargeable batteries. Other types of batteries may burst, causing personal injury and damage.
4. **NEVER** cause AC output and DC input short circuit. Don't connect to the mains when DC input short circuits.
5. **NEVER** charge a frozen battery.
6. Do not disassemble the unit. Take it to a qualified service center when service or repair is required. Incorrect re-assembly may result in a risk of electric shock or fire.
7. To reduce risk of electric shock, disconnect all wiring before attempting any maintenance or cleaning. Turning off the unit will not reduce this risk.
8. Be very cautious when working with metal tools on or around batteries. A potential risk, such as dropping a tool to spark or short circuit batteries or other electrical parts, could cause an explosion.
9. For optimum operation of this off grid solar inverter, please follow required spec to select appropriate cable size. It's very important to correctly operate this off grid solar inverter.
10. Please strictly follow installation procedure when you want to disconnect AC or DC terminals. Please refer to INSTALLATION section of this manual for the details.
11. **GROUNDING INSTRUCTIONS** –This off grid solar inverter should be connected to a permanent grounded wiring system. Be sure to comply with local requirements and regulation to install this inverter.
12. **Warning!!** Only qualified service persons are able to service this device. If errors still persist after following troubleshooting table, please contact local dealer or service center for maintenance.

Introduction

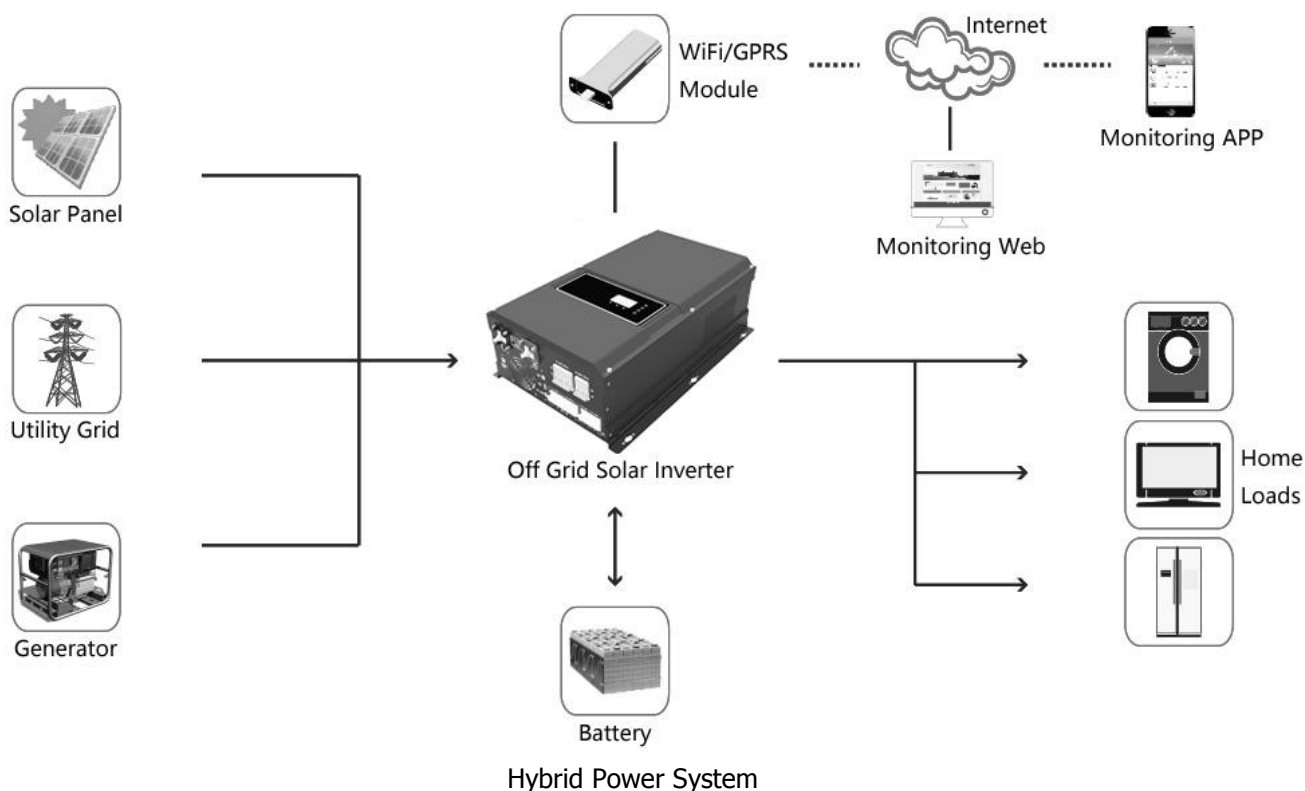

This is a multifunctional split-phase output off grid solar inverter, integrated with a MPPT solar charge controller, a low frequency pure sine wave inverter and a UPS function module in one machine, which is perfect for off grid backup power and self-consumption applications.

The whole system also need other devices to achieve complete running such as PV modules, generator, or utility grid. Please consult with your system integrator for other possible system architectures depending on your requirements. The WiFi / GPRS module is a plug-and-play monitoring device to be installed on the inverter. With this device, users can monitor the status of the PV system from the mobile phone or from the website anytime anywhere.

Features

- ▶ Rated power 4KW to 12KW
- ▶ MPPT solar charge controller
- ▶ Low frequency inverter with large transformer
- ▶ Pure sine wave AC output
- ▶ Overload, short circuit and deep discharge protection
- ▶ Configurable AC/ solar input priority via LCD setting
- ▶ Compatible to mains voltage or generator power
- ▶ WiFi/ GPRS remote monitoring

Product Overview

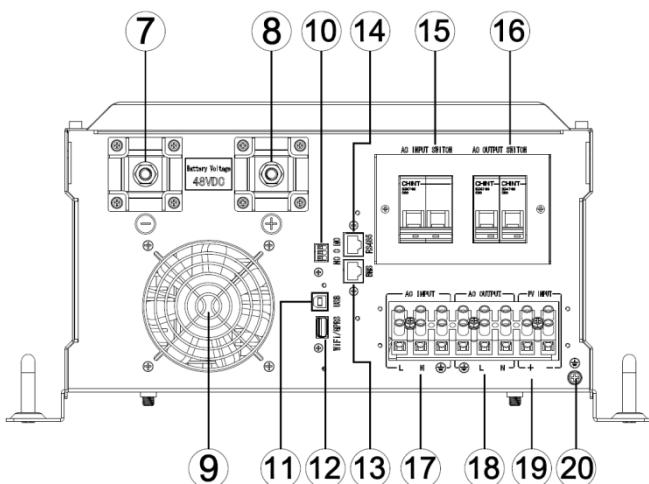
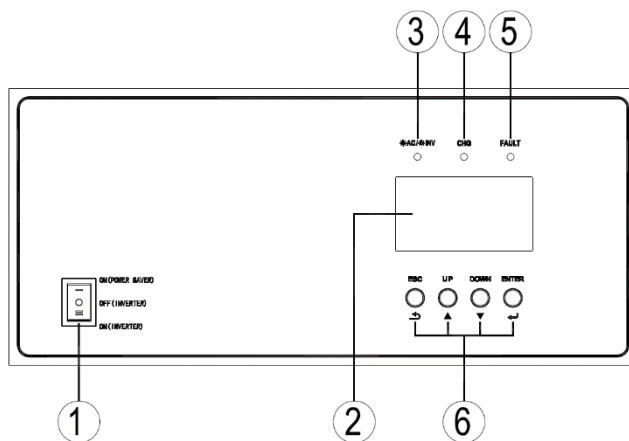
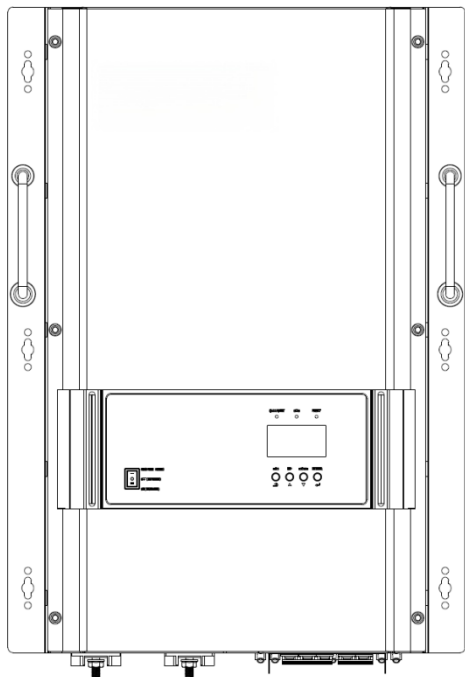

(4KW/5KW/6KW)

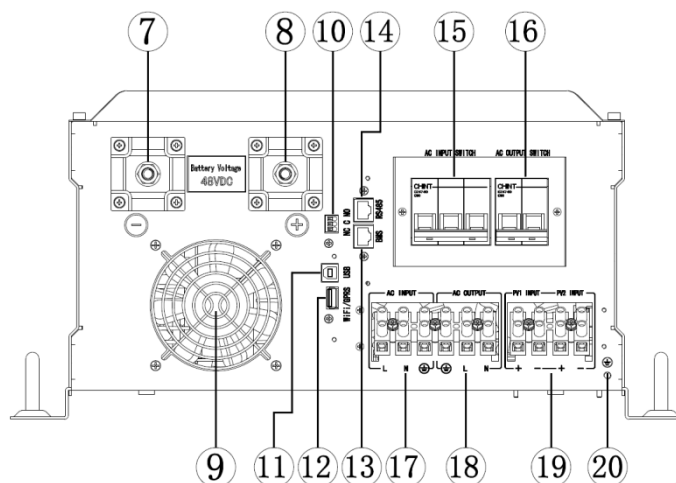

(8KW/10KW/12KW)

- 1. ON/OFF Power Switch
- 3. Status Indicator
- 5. Fault Indicator
- 7. Negative Battery Terminal
- 9. DC Fan
- 11. USB Port
- 13. BMS Port
- 15. AC Input Breaker
- 17. AC Input Terminal
- 19. PV Input Terminal

- 2. LCD Display
- 4. Charging Indicator
- 6. Function Buttons
- 8. Positive Battery Terminal
- 10. Dry Contact For AGS
- 12. Wi-Fi/GPRS Device Port
- 14. RS485/Remote LCD Port (Optional)
- 16. AC Output Breaker
- 18. AC Output Terminal
- 20. Grounding Terminal

Installation

Unpacking and Inspection

Before installation, please inspect the unit. Be sure that nothing inside the package is damaged. You should have received the following items in the package:

- ▶ The unit x1
- ▶ User manual x 1
- ▶ Communication cable x 1

Preparation

Before connecting all wiring, please take off bottom cover by removing eight screws as shown below.

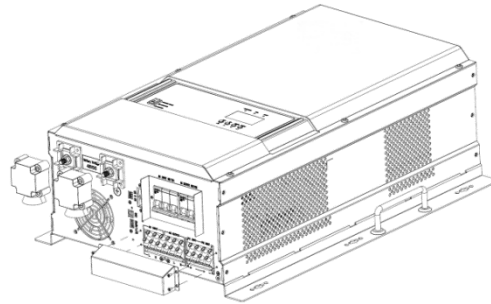

Mounting the Unit

Consider the following points before selecting where to install:

- ▶ Do not mount the inverter on flammable construction materials.
- ▶ Mount on a solid surface
- ▶ Install this inverter at eye level in order to allow the LCD display to be read at all times.
- ▶ The ambient temperature should be between 0°C and 50°C to ensure optimal operation.
- ▶ The recommended installation position is to be adhered to the wall vertically.
- ▶ Be sure to keep other objects and surfaces as shown in the right diagram to guarantee sufficient heat dissipation and to have enough space for removing wires.

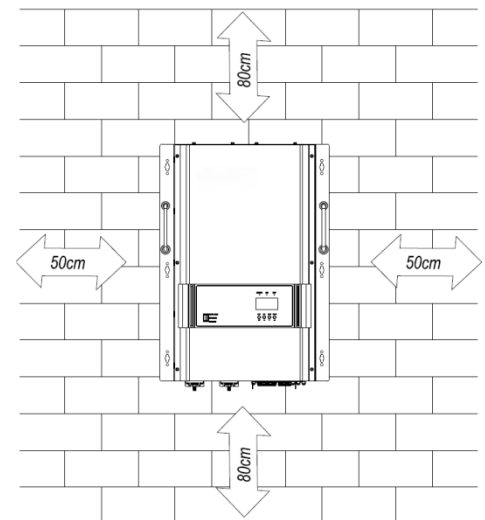

SUITABLE FOR MOUNTING ON CONCRETE OR OTHER NON-COMBUSTIBLE SURFACE ONLY

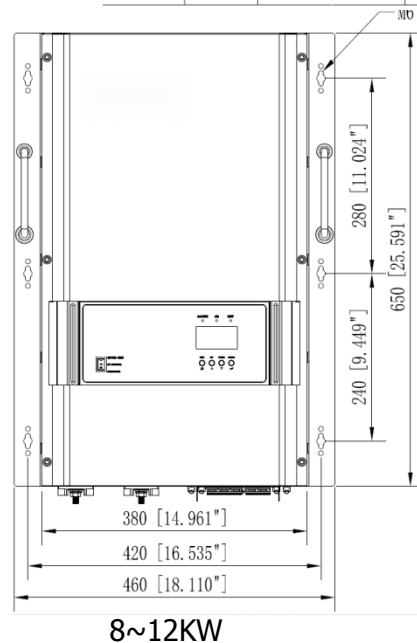
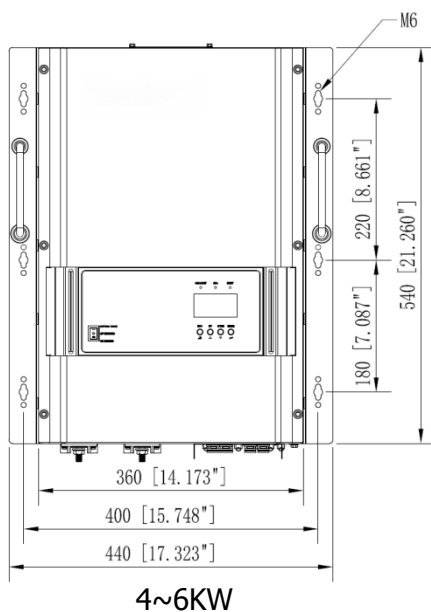

Install the unit by screwing the six setscrews.

Battery Connection

CAUTION: For safety operation and regulation compliance, it's requested to install a separate DC over-current protector or disconnect device between battery and inverter. It may not be requested to have a disconnect device in some applications, however, it's still requested to have over-current protection installed. Please refer to typical amperage in below table as required fuse or breaker size.

WARNING! All wiring must be performed by a qualified person.

WARNING! It's very important for system safety and efficient operation to use appropriate cable for battery connection. To reduce risk of injury, please use the proper recommended cable and terminal size as below.

Recommended battery cable and terminal size:

Model	Battery Voltage	Wire Gage/min 0~1.0m	Wire Gage/min 1.0~5.0m
4kw	48V	30 mm ²	40 mm ²
5kw	48V	40 mm ²	50 mm ²
6kw	48V	50 mm ²	60 mm ²
8kw	48V	60 mm ²	75 mm ²
10kw	48V	75 mm ²	90 mm ²
12kw	48V	90 mm ²	120 mm ²

Please follow below steps to implement battery connection:

1. Assemble battery ring terminal based on recommended battery cable and terminal size.
2. Connect all battery packs as units requires. It's suggested to connect at least 200Ah capacity battery for 4KW~6KW model and at least 400Ah capacity battery for 8KW~12KW model.
3. Insert the ring terminal of battery cable flatly into battery connector of inverter and make sure the bolts are tightened with torque of 2-3 Nm. Make sure polarity at both the battery and the inverter/charge is correctly connected and ring terminals are tightly screwed to the battery terminals.

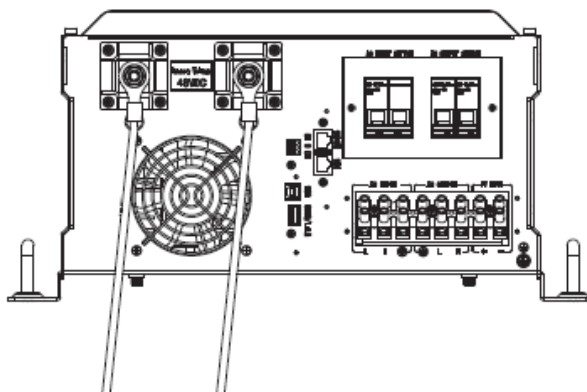

 **WARNING: Shock Hazard**
Installation must be performed with care due to high battery voltage in series.

 **CAUTION!!** Do not place anything between the flat part of the inverter terminal and the ring terminal. Otherwise, overheating may occur.
CAUTION!! Do not apply anti-oxidant substance on the terminals before terminals are connected tightly.
CAUTION!! Before making the final DC connection or closing DC breaker/disconnector, be sure positive (+) must be connected to positive (+) and negative (-) must be connected to negative (-).

Lithium battery connection

If need to communicate with lithium battery BMS, the inverter protocol should have matched the BMS first. There're two connectors on the lithium battery, RJ45 port of BMS and power cable. Please follow below steps to implement lithium battery connection:

1. Assemble battery ring terminal based on recommended battery cable and terminal size (recommended standards are in the previous page) .
2. Insert the ring terminal of battery cable flatly into battery connector of inverter and make sure the bolts are tightened with torque of 2-3Nm. Make sure polarity at both the battery and the inverter/charge is correctly connected and ring terminals are tightly screwed to the battery terminals
3. Connect the end of RJ45 of battery to BMS communication port of inverter.

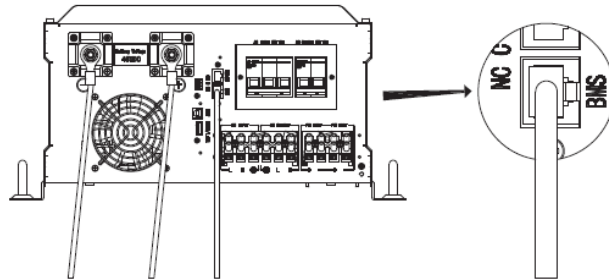

4. The other end of RJ45 insert to battery comm port.

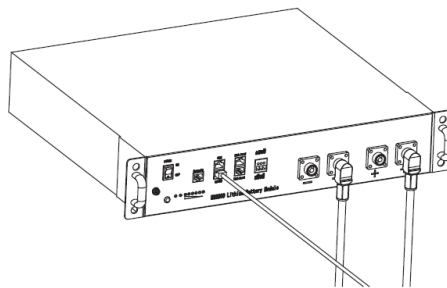

Note: if choosing lithium battery, make sure to connect the BMS communication cable between the battery and the inverter. You need to choose battery type as "lithium battery".

Lithium battery communication and setting

In order to communicate with battery BMS, you should set the battery type to "LI" in Program 5. Then the LCD will switch to Program 51, which is to set the protocol type. There are several protocols in the inverter. Please get instruction from the supplier to choose which protocol to match the BMS.

1. Connect the end of RJ45 of battery to BMS communication port of inverter

Make sure the lithium battery BMS port connects to the inverter is Pin to Pin. The BMS port supports communication with BMS by RS485 protocol or CAN protocol.

The inverter BMS port pin and RS485 port pin assignment shown as below.

Pin number	BMS port	RS485 port (for expansion)
1	RS485B	RS485B
2	RS485A	RS485A
3	--	--
4	CANH	--
5	CANL	--
6	--	--
7	--	--
8	--	--

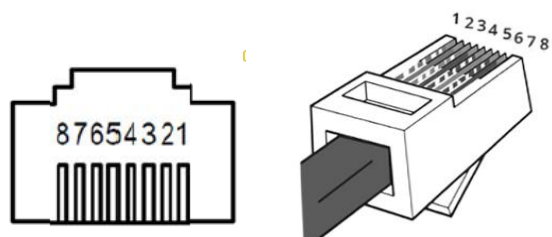

2. LCD setting

To connect battery BMS, need to set the battery type as "LI" in Program 05.

After set "LI" in Program 05, it will switch to Program 51 to choose communication protocol. You can choose RS 485 communication protocol which is from L01 to L50, and you can also choose CAN communication protocol which is from L51 to L99.

Note: You can only use one communication type RS485 or CAN in a time.

05	Battery type	AGM (Default) AGM 05
		Flood FLd 05
		User-Defined USE 05 If "User-Defined" is selected, battery charge voltage and low DC cut-off voltage can be set up in program 19, 20 and 21.
		User-Defined 2 (Suitable for lithium battery when no communicating with BMS) US2 05 If 'US2' is selected, battery charge voltage and low DC cut-off voltage can be set up in program 19,20 and 21.
		Lithium (Only suitable when communicate with BMS) LI 05 The lithium battery BMS communication protocol options L01 51 L02 51 L03 51 L04 51

When the battery type set to Li, the setting option 12, 13, 21 will change to display percent.

Note: When the battery type set as "LI", the Maximum charge current can't be modified by the user. When the communication fail, the inverter will cut off output.

12	Setting SOC point back to utility source when selecting "SBU priority" or "Solar first" in program 01	40% 12 Default 40%, 5%~50% Settable
13	Setting SOC point back to battery mode when selecting "SBU priority" or "Solar first" in program 01	80% 13 Default 80%, 60%~100% Settable

21	Low DC cut-off voltage. If self-defined is selected in program 5, this program can be set up	COV 20% 21 Default 20%, 5%~50% Settable
----	---	--

AC Input/Output Connection

CAUTION!!

Before connecting to AC input power source, please install a separate AC breaker between inverter and AC input power source. This will ensure the inverter can be securely disconnected during maintenance and fully protected from over current of AC input. The recommended spec of AC breaker is 40A for 4KW~6KW, 80A for 8KW~12KW.

There are two terminal blocks with "IN" and "OUT" markings. Please do NOT mis-connect input and output connectors.

WARNING! !

All wiring must be performed by a qualified personnel.

It's very important for system safety and efficient operation to use appropriate cable for AC input connection. To reduce risk of injury, please use the proper recommended cable size as below.

Suggested cable requirement for AC wires

Model	Gauge	Torque Value
4KW/5KW	10 AWG	1.4~ 1.6 Nm
6KW/8KW	8 AWG	1.4~ 1.6 Nm
10KW/12KW	6 AWG	1.6~ 1.8 Nm

AC Wiring

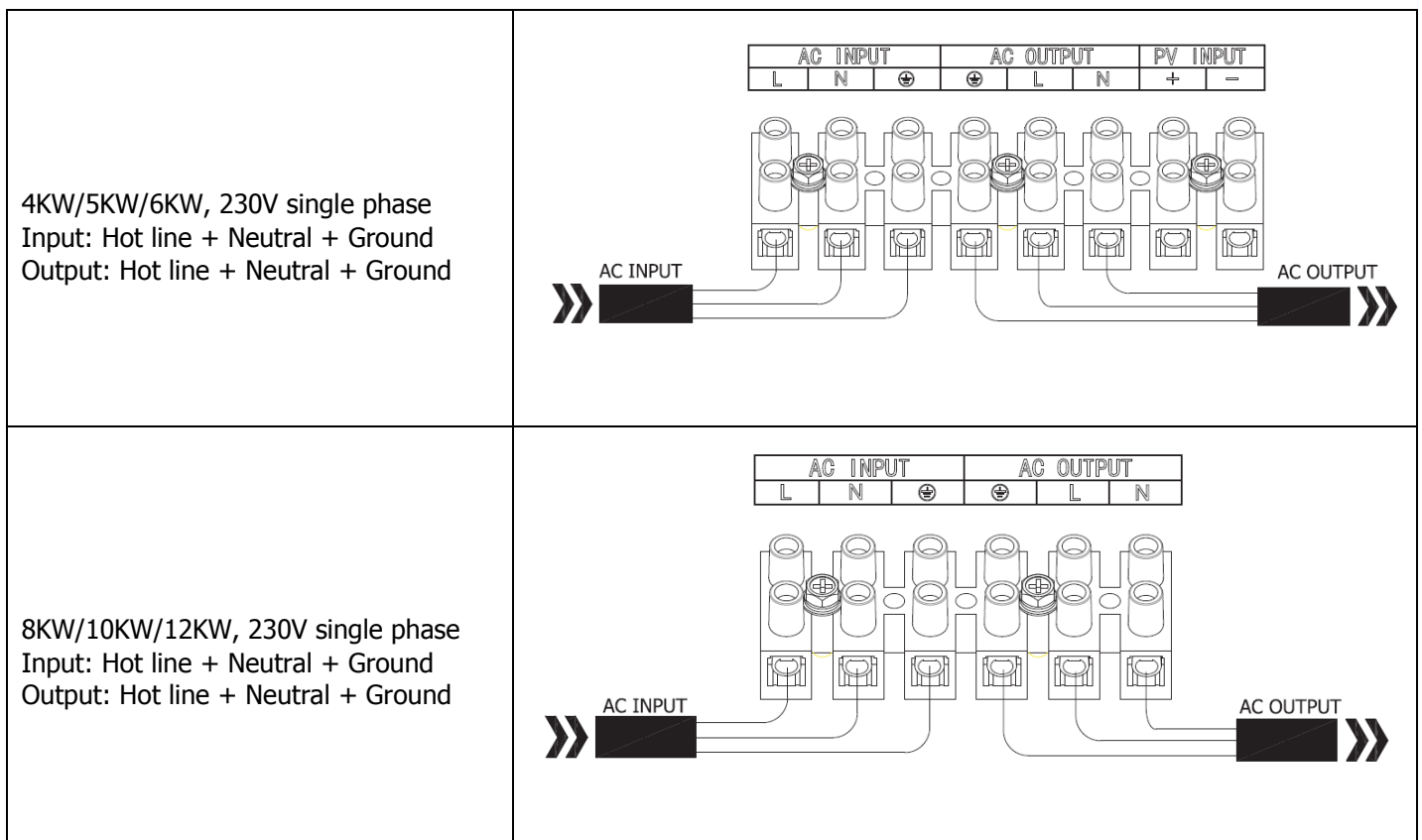

Please follow below steps to implement AC input/output connection:

1. Before making AC input/output connection, be sure to open DC protector or disconnecter first.
2. Remove insulation sleeve 10mm for six conductors. And shorten phase L and neutral conductor N 3 mm.
3. Insert AC input wires according to polarities indicated on terminal block and tighten the terminal screws. Be sure to connect PE protective conductor \oplus first.

- L --> Live wire (brown or black)
- N --> Neutral wire (blue)
- Ground --> Earth wire (yellow and green)

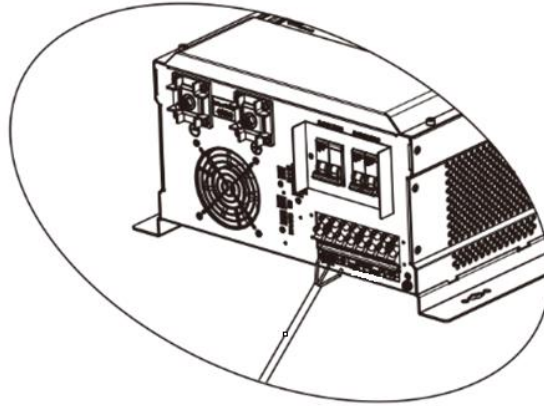

 **WARNING:** Be sure that AC power source is disconnected before attempting to hardwire it to the unit.

4. Then, insert AC output wires according to polarities indicated on terminal block and tighten terminal screws.

- L --> Live wire (brown or black)
- N --> Neutral wire (blue)
- Ground --> Earth wire (yellow and green)

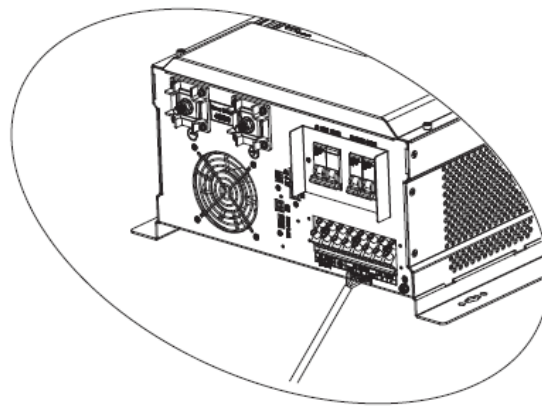

5. Make sure the wires are securely connected.

CAUTION: Important

Be sure to connect AC wires with correct polarity. If L and N wires are connected reversely, it may cause utility short-circuited when these inverters are worked in parallel operation.

CAUTION: Appliances such as air conditioner are required at least 2~3 minutes to restart because it's required to have enough time to balance refrigerant gas inside of circuits. If a power shortage occurs and recovers in a short time, it will cause damage to your connected appliances. To prevent this kind of damage, please check with manufacturer of air conditioner that if it's equipped with time-delay function before installation. Otherwise, this off grid solar inverter will trigger overload fault and cut off output to protect your appliance, but sometimes it still causes internal damage to the air conditioner.

PV Connection

CAUTION: Before connecting to PV modules, please install separately a DC circuit breaker between inverter and PV modules.

WARNING! All wiring must be performed by a qualified personnel.

WARNING! It's very important for system safety and efficient operation to use appropriate cable for PV module connection. To reduce risk of injury, please use the proper recommended cable size as below.

Model	Typical Amperage	Cable Size	Torque
4KW/5KW/6KW	80A	8AWG	1.6~1.8 Nm
8KW/10KW/12KW	120A	8AWG	1.6~1.8 Nm

PV Module Selection:

When selecting proper PV modules, please be sure to consider below parameters:

1. Open circuit Voltage (Voc) of PV modules not exceeds max. PV array open circuit voltage of inverter.
2. Open circuit Voltage (Voc) of PV modules should be higher than min. battery voltage.

Solar Charging Mode	
INVERTER MODEL	4KW/5KW/6KW/8KW/10KW/12KW
Max. PV Array Open Circuit Voltage	150Vdc
PV Array MPPT Voltage Range	60~145Vdc

Please follow below steps to implement PV module connection:

1. Remove insulation sleeve 10 mm for positive and negative conductors.
2. Check correct polarity of connection cable from PV modules and PV input connectors. Then, connect positive pole (+) of connection cable to positive pole (+) of PV input connector. Connect negative pole (-) of connection cable to negative pole (-) of PV input connector.
3. Make sure the wires are securely connected.

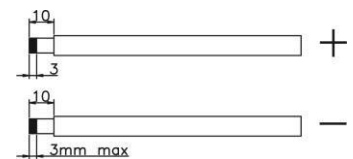

PV Wiring

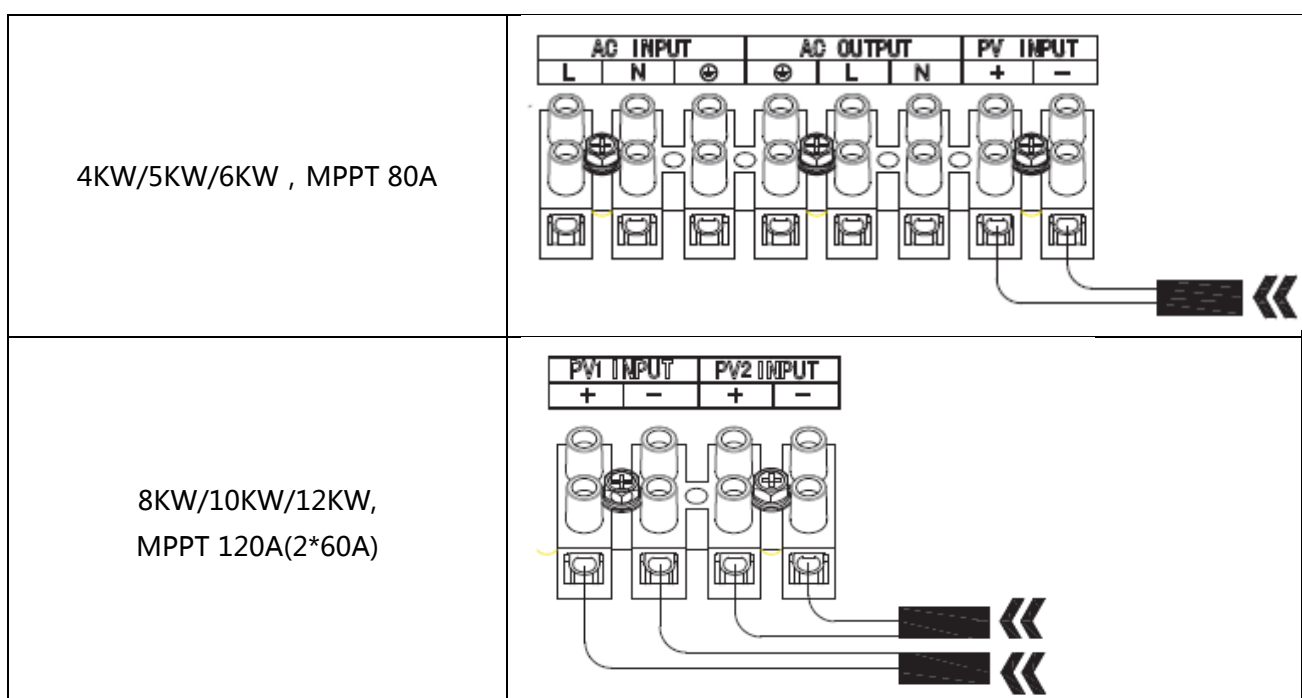

Communication Connection

Please use supplied communication cable to connect to inverter and PC. Follow on-screen instruction to install the monitoring software. For the detailed software operation, please check user manual of software. The monitoring software is downloadable from our website www.ginverter.com.

Dry Contact Signal

There is one dry contact (3A/250VAC) available on the rear panel. It could be used to deliver signal to generator when battery voltage reaches warning level.

Unit Status	Condition		Dry contact port: 	
			NC & C	NO & C
Power Off	Unit is off and no output is powered.		Close	Open
Power On	Output is off and no output is powered		Close	Open
	Battery not in "LI" mode	Battery voltage < Low DC Cut-off Voltage +2Vdc	Open	Close
		Detected there's AC input	Close	Open
	Battery in "LI" mode	Battery SOC < Low DC Cut-off Soc+5%	Open	Close
Detected there's AC input		Close	Open	

Electrical Performance

Inverting

Overload Capacity

1. For $100\% < \text{Load} < 120\%$, Fault (Power off) after 10 seconds.
2. For $120\% < \text{Load} \leq 300\%$, Fault (Power off) after the 5 seconds.

Soft Start in Inverter Mode

When the inverter is turned on, the output voltage gradually ramps up from 0VAC to rated voltage in about 1.2 sec. This effectively reduces otherwise very high starting inrush current drawn by AC loads such as Switched Mode Power Supplies and inductive loads. This will result in lower motor inrush current, which means less impact on the loads and inverter.

Caution:

After the inverter is switched on, it takes a finite amount of time to self-diagnose and get ready to deliver full power. Always switch on the load(s) after a few seconds of switching on the inverter. Avoid switching on the inverter with the load already switched on. This may prematurely trigger the overload protection. When a load is switched on, it may require an initial higher power surge to start. If multiple loads are being powered, they should be switched on individually so that the inverter is not overloaded by the higher starting surge.

AC Charger

The inverter is equipped with an active PFC (power factor correction) multistage battery charger. The PFC feature is used to control the amount of power used to charge the batteries in order to obtain a power factor as close as possible to 1.

When AC voltage is in the range of 154~260VAC, the charging current is 100%. Once it exceeds 260VAC, it must be restored to 250VAC before it can be charged.

The inverter/charger has a very rapid charge current available, and the max charge current can be adjusted from 10A to 100A in small increments on the inverter's LCD. This is helpful if this powerful charger applies charging to a small capacity battery bank.

There are mainly 3 stages:

Bulk Charging: This is the initial stage of charging. While Bulk Charging, the charger supplies the battery with controlled constant current. The charger will remain in Bulk charge until the absorption charge voltage is achieved.

Absorb Charging: This is the second charging stage and begins after the absorb voltage has been reached. Absorb charging provides the batteries with a constant voltage and reduces the DC charging current in order to maintain the absorb voltage setting.

In this period, the inverter will start a T1 time; the charger will keep the boost voltage in Boost CV mode until the T1 time has run out. When charging current is $<0.01C$ or the time is over 12 hours, then drop the voltage Down to the float voltage.

Float Charging: The third charging stage occurs at the end of the absorb charging time. During float charging, the charge voltage is reduced to the float charge voltage. In this stage, the battery are kept fully charged and ready if needed by the inverter.

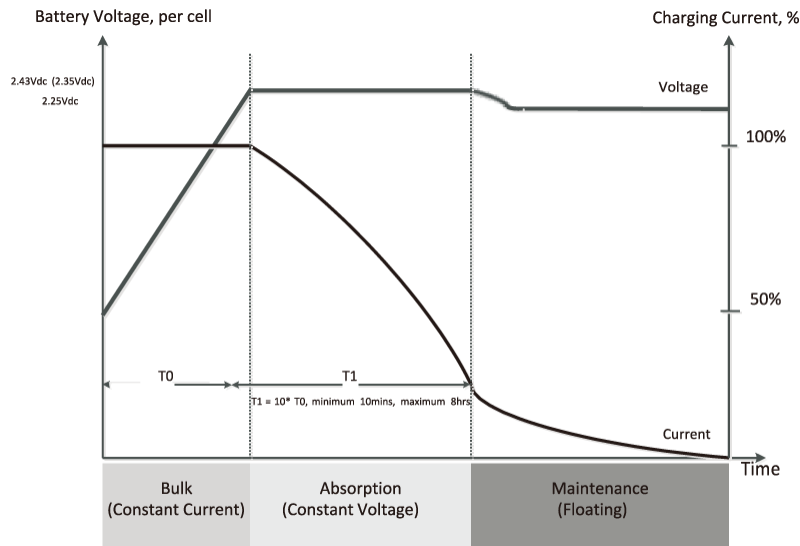

AC Charging Current:

Model	Battery Voltage	Max. AC Charging Current
4KW	48V	40A
5KW	48V	50A
6KW	48V	60A
8KW	48V	70A
10KW	48V	80A
12KW	48V	100A

MPPT Charging Current:

Model	Battery Voltage	Max. Charging Current
4-6KW	48V	80A
8-12KW	48V	120A

Battery Equalization

Equalization function is added into charge controller. It reverses the buildup of negative chemical effects like stratification, a condition where acid concentration is greater at the bottom of the battery than at the top. Equalization also helps to remove sulfate crystals that might have built up on the plates. If left unchecked, this condition, called sulfation, will reduce the overall capacity of the battery. Therefore, it's recommended to equalize battery periodically.

- **How to Apply Equalization Function**

You must enable battery equalization function in monitoring LCD setting program 23 first. Then, you may apply this function in device by either one of following methods:

1. Setting equalization interval in program 27.
2. Active equalization immediately in program 28.

- **When to Equalize**

In float stage, when the setting equalization interval (battery equalization cycle) is arrived, or equalization is active immediately, the controller will start to enter Equalize stage.

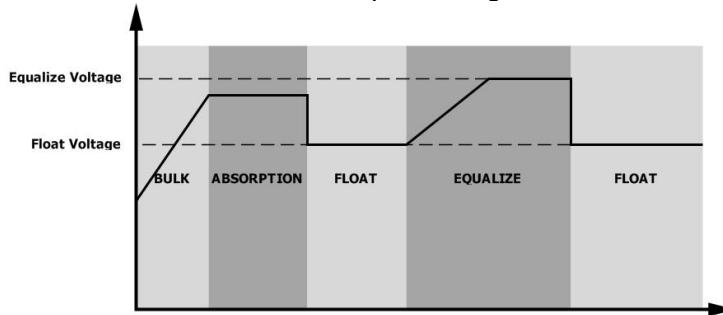

- **Equalize charging time and timeout**

In Equalize stage, the controller will supply power to charge battery as much as possible until battery voltage raises to battery equalization voltage. Then, constant-voltage regulation is applied to maintain battery voltage at the battery equalization voltage. The battery will remain in the Equalize stage until setting battery equalized time is arrived.

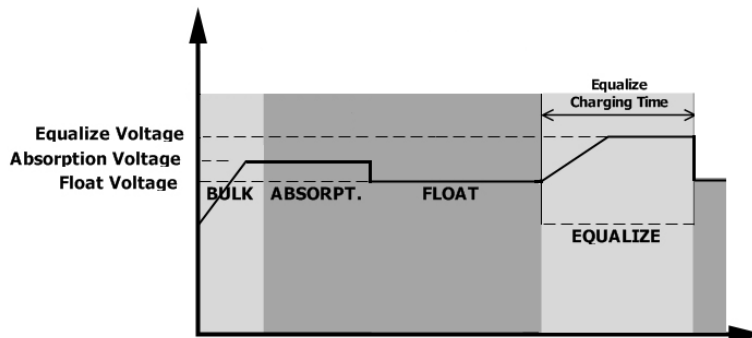

However, in Equalize stage, when battery equalized time is expired and battery voltage doesn't rise to battery equalization voltage point, the charge controller will extend the battery equalized time until battery voltage achieves battery equalization voltage. If battery voltage is still lower than battery equalization voltage when battery equalized timeout setting is over, the charge controller will stop equalization and return to float stage.

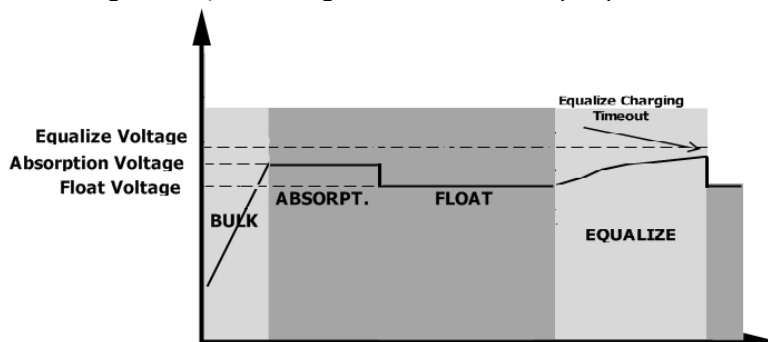

Power Saver

The "Power Saver" function is dedicated to conserve battery power when AC power demand is either minimal or not required at all by the loads.

In this mode, the inverter pulses the AC output looking for an AC load (i.e., electrical appliance). Whenever an AC load (greater than 500 watts at 120Vac) is turned on, the inverter recognizes the need for power and automatically starts inverting and output goes to full voltage. When there is no load (or less than 500 watts) detected, the inverter automatically goes back into search mode to minimize energy consumption from the battery bank.

In "Power saver on" mode, the inverter will draw power mainly in sensing moments, thus the idle consumption is significantly reduced.

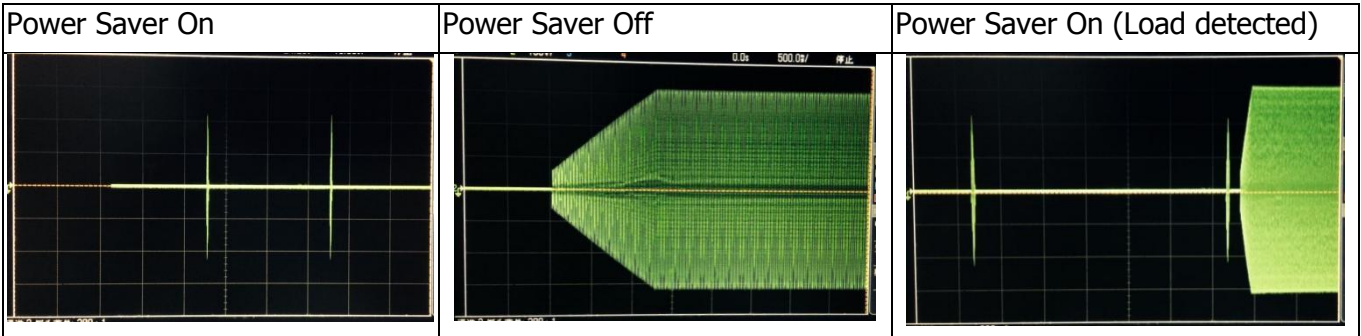

FAN Operation

For 4-6KW models, there are one DC fan and one AC fan.

For 8-12KW models, there are one DC fans and two AC fan.

The fans are designed to operate according to the following logic:

Condition	Enter Condition	Leave condition	Fan Speed
HEAT SINK TEMPERATURE	$T \leq 40^{\circ}\text{C}(104^{\circ}\text{F})$	$T > 40^{\circ}\text{C}(104^{\circ}\text{F})$	OFF
	$T > 40^{\circ}\text{C}(104^{\circ}\text{F})$	$T \leq 40^{\circ}\text{C}(104^{\circ}\text{F})$	ON
UTLITY CHARGER CURRENT	$I \leq 20\text{A}$	$I > 20\text{A}$	OFF
	$I > 20\text{A}$	$I \leq 20\text{A}$	ON
LOAD PERCENTAGE (INV MODE)	$20\% \leq \text{Load}$	$\text{Load} > 20\%$	OFF
	$\text{Load} > 20\%$	$20\% \leq \text{Load}$	ON

Allow at least 80CM of clearance around the inverter for air flow. Make sure that the air can circulate freely around the unit.

Output Power Derating

When DC input voltage drops to Low DC Warning Voltage OR Low DC Warning SOC, the output Voltage will be derated 10V.

When transformer temperature exceed to 150°C , the output Voltage will be derated 10V.

Remote LCD Connecting (Optional)

Plug in the remote LCD panel to the RS485 port.

There's a DIP switch on the inverter communication board. Change the DIP switch setting to all "ON" as picture showed as below.

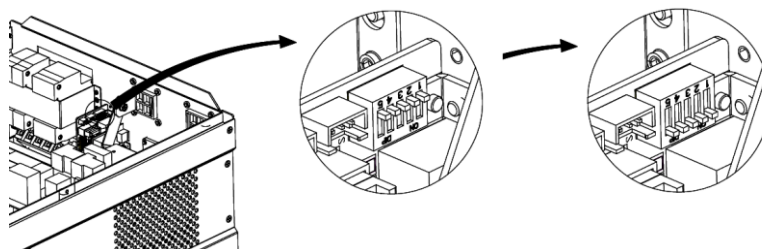

Warning:

Our cables are designed with special pinouts on the connectors, so don't use other cables, or the remote LCD panel will not be powered on.

Operation

Power ON/OFF

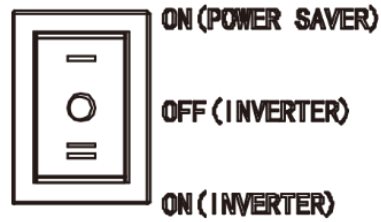
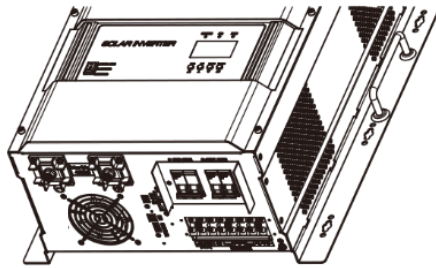

Once the unit has been properly installed and the batteries are connected well, simply press On/Off switch (located on the button of the case) to turn on the unit.

Operation and Display Panel

The operation and display panel, shown in below chart, is on the front panel of the inverter. It includes three indicators, four function keys and a LCD display, indicating the operating status and input/output power information.

1. LCD display
2. Status indicator
3. Charging indicator
4. Fault indicator
5. Function buttons

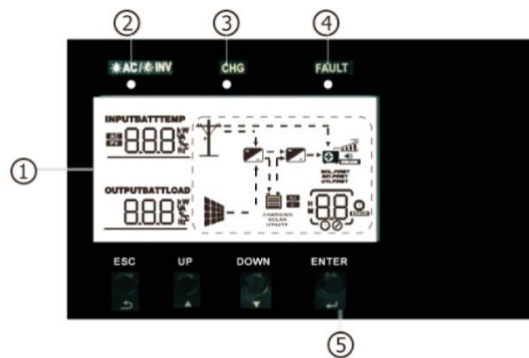

LED Indicator

LED Indicator		Messages	
☀️ AC / 🌙 INV	Green	Solid On	Output is powered by utility in Line mode.
		Flashing	Output is powered by battery or PV in battery mode.
☀️ CHG	Green	Solid On	Battery is fully charged.
		Flashing	Battery is charging.
⚠️ FAULT	Red	Solid On	Fault occurs in the inverter.
		Flashing	Warning condition occurs in the inverter.

Function Buttons

Button	Description
ESC	To exit setting mode
UP	To go to previous selection
DOWN	To go to next selection
ENTER	To confirm the selection in setting mode or enter setting mode

LCD Display Icons

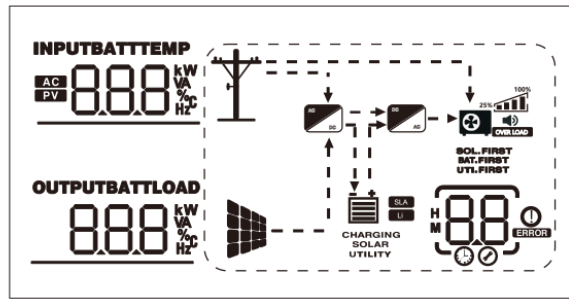

Icon	Function Description	
Input Source Information		
	Indicates the AC input.	
	Indicates the PV input	
	Indicate input voltage, input frequency, PV voltage, battery voltage and charger current.	
Configuration Program and Fault Information		
	Indicates the setting programs.	
	Indicates the warning and fault codes.	
		Warning: flashing with warning code.
	Fault: lighting with fault code	
Output Information		
	Indicate output voltage, output frequency, load percent, load in VA, load in Watt and discharging current.	
Battery Information		
	Indicates battery level by 0-24%, 25-49%, 50-74% and 75-100% in battery mode and charging status in line mode.	
	These two signs indicate the charge priority. SOLAR indicates solar first. UTILITY indicate utility first. SOLAR blinking indicates solar only; SOLAR and UTILITY both on indicates combined charging.	
In AC mode, it will present battery charging status.		
Status	Battery voltage	LCD Display
Constant Current mode / Constant Voltage mode	<2V/cell	4 bars will flash in turns.
	2 ~ 2.083V/cell	Bottom bar will be on and the other three bars will flash in turns.
	2.083 ~ 2.167V/cell	Bottom two bars will be on and the other two bars will flash in turns.
	> 2.167 V/cell	Bottom three bars will be on and the top bar will flash.
Floating mode. Batteries are fully charged.		4 bars will be on.

In battery mode, it will present battery capacity.

Load Percentage	Battery Voltage	LCD Display
Load > 50%	< 1.717V/cell	
	1.717V/cell ~ 1.8V/cell	
	1.8 ~ 1.883V/cell	
	> 1.883 V/cell	
50% > Load > 20%	< 1.817V/cell	
	1.817V/cell ~ 1.9V/cell	
	1.9 ~ 1.983V/cell	
	> 1.983	
Load < 20%	< 1.867V/cell	
	1.867V/cell ~ 1.95V/cell	
	1.95 ~ 2.033V/cell	
	> 2.033	

Load Information

OVER LOAD	Indicates overload.			
	Indicates the load level by 0-24%, 25-49%, 50-74% and 75-100%.			
	0%~24%	25%~49%	50%~74%	75%~100%

Mode Operation Information

	Indicates unit connects to the mains.
	Indicates unit connects to the PV panel.
BYPASS	Indicates load is supplied by utility power.
	Indicates the utility charger circuit is working.
	Indicates the DC/AC inverter circuit is working.
SOL.FIRST BAT.FIRST UTI.FIRST	These three sins indicate the output priority. SOL.FIRST indicates solar first. BAT.FIRST indicates battery first. UTI.FIRST indicates utility first.

Mute Operation

	Indicates unit alarm is disabled.
--	-----------------------------------

LCD Setting

After pressing and holding ENTER button for 3 seconds, the unit will enter setting mode. Press "UP" or "DOWN" button to select setting programs. And then, press "ENTER" button to confirm the selection or ESC button to exit.

Setting Programs:

Program	Description	Setting Option	
01	Output source priority: To configure load power source priority	Solar first	SOL 01 ⊙
		Solar energy provides power to the loads as first priority. If solar energy is not sufficient to power all connected loads, battery energy will supply power the loads at the same time. Utility provides power to the loads only when any one condition happens: - Solar energy is notavailable - Battery voltage drops toeither low-level warning voltage orthe setting point in program12.	
		Utility first (default)	UTI 01 ⊙
		Utility will provide power to the loads as first priority. Solar and battery energy will provide power to the loads only when utilitypower is not available.	
02	Maximum charging current: To configure total charging current for solar and utility chargers. (Max. charging current = utility charging current + solar charging current)	SBU priority	SBU 01 ⊙
		Solar energy provides power to the loads as first priority. If solar energy is not sufficient to power all connected loads, battery energy will supply power to the loads at the same time. Utility provides power to the loads only when battery voltage drops to either low-level warning voltage or thesetting point in program 12.	
02		80 ^A	02 ⊙ 12KW model: default 80A, 10A~180A Settable 10KW model: default 80A, 10A~160A Settable 8KW model: default 80A, 10A~150A Settable 6KW model: default 80A, 10A~140A Settable 5KW model: default 80A, 10A~130A Settable 4KW model: default 80A, 10A~120A Settable (If Li is selected in program 5, this program can't be set up)

03	AC input voltage range	APL 03 Appliance (default)	If selected, acceptable AC input voltage range will be within 154~272VAC
		UPS 03 UPS	If selected, acceptable AC input voltage range will be within 184~272VAC
05	Battery type	AGM (Default) AGM 05	
		Flood FLd 05	
		User-Defined USE 05	If "User-Defined" is selected, battery charge voltage and low DC cut-off voltage can be set up in program 19, 20 and 21.
		User-Defined 2 (Suitable for lithium battery when no communicating with BMS) US2 05	If 'US2' is selected, battery charge voltage and low DC cut-off voltage can be set up in program 19,20 and 21.
		Lithium (Only suitable when communicate with BMS) LI 05	The lithium battery BMS communication protocol options L01 51 L02 51 L03 51 L04 51
06	Auto restart when overload occurs	Restart disable (default) Lfd 06	Restart enable LFE 06
		230V(default) 230 ^v 08	220V 220 ^v 08
08	Output voltage	240V 240 ^v 08	208V 208 ^v 08
		50Hz (default) 50 _{Hz} 09	60Hz 60 _{Hz} 09
09	Output frequency		

11	Maximum utility charging current	<p>30^A 11</p> <p>12KW model: default 30A, 10A~100A Settable 10KW model: default 30A, 10A~80A Settable 8KW model: default 30A, 10A~70A Settable 6KW model: default 30A, 10A~60A Settable 5KW model: default 30A, 10A~50A Settable 4KW model: default 30A, 10A~40A Settable (If Li is selected in program 5, this program can't be set up)</p>	
12	Setting voltage point back to utility source when selecting "SBU priority" or "Solar first" in program 01	<p>46.0^v 12</p> <p>48V model: default 46.0V, 44.0V~51.2V settable</p>	
		<p>40% 12</p> <p>48V model Lithium mode: default 40%, 5%~50% settable</p>	
13	Setting voltage point back to battery mode when selecting "SBU priority" or "Solar first" in program 01	<p>54.0^v 13</p> <p>48V model: default 54.0V, 48.0V~58.0V Settable</p>	
		<p>80% 13</p> <p>48V model Lithium mode: default 80%, 60%~100% settable</p>	
14	Charger source priority: To configure charger source priority	<p>If this off grid solar inverter is working in Line, Standby or Faultmode, charger source can be programmed as below:</p>	
		<p>Solar first</p> <p>C50 14</p>	<p>Solar energy will charge battery as first priority. Utility will charge battery only when solar energy is not available.</p>
		<p>Utility first</p> <p>CUT 14</p>	<p>Utility will charge battery as first priority. Solar energy will charge battery only when utility power is not available.</p>
		<p>Solar and Utility (Default)</p> <p>SNU 14</p>	<p>Solar energy and utility will both charge battery.</p>
		<p>Only Solar</p> <p>O50 14</p>	<p>Solar energy will be the only charger source no matter utility is available or not.</p>
<p>If this off grid solar inverter is working in Battery mode or Power saving mode, only solar energy can charge battery. Solar energy will charge battery if it's available and sufficient.</p>			

15	Alarm control	Alarm on (default) b0n 15 ⊙	Alarm off b0F 15 ⊙
16	Backlight control	Backlight on (default) L0n 16 ⊙	Backlight off L0F 16 ⊙
17	Beeps while primary source is interrupted	Alarm on (default) A0n 17 ⊙	Alarm off A0F 17 ⊙
19	C.V. charging voltage If self-defined is selected in program 5, this program can be set up	Cv 56.4v 19 ⊙ 48V model: default 56.4V, 48.0V~58.4V Settable	
20	Floating charging voltage. If self-defined is selected in program 5, this program can be set up	FLV 54.0v 20 ⊙ 48V model: default 54.0V, 48.0V~58.4V Settable	
21	Low DC cut-off voltage. If self-defined is selected in program 5, this program can be set up	COV 42.0v 21 ⊙ 48V model: default 42.0V, 40.0V~48.0V Settable	
		20% 21 ⊙ Lithium battery mode: default 20%, 5%~50% Settable	
22	RS485 communication address	Adt 001 22 ⊙ Default 001,001-255 Settable	
23	Battery equalization	Disabled (Default) E9 d15 23 ⊙	Enable E9 ENR 23 ⊙
		If "Flooded" or "User-Defined" is selected in program this program can be set up.	



24	Battery equalization voltage	<p>48V model: default 58.4V, 48~60V Settable</p> <p>EQV</p> <p>58.4V 24</p>	
25	Battery equalized time	<p>Setting range is from 5 minutes to 900 minutes. Increment of each click is 1 minute</p> <p>Edt</p> <p>060 25</p>	
26	Battery equalized timeout	<p>Setting range is from 5 minutes to 900 minutes. Increment of each click is 1 minute</p> <p>EtO</p> <p>120 26</p>	
27	Equalization interval	<p>Setting range is from 1 day to 30 days. Increment of each click is 1 day</p> <p>EIt</p> <p>001 27</p>	
28	Equalization activated immediately	<p>Disabled (Default)</p> <p>AtV</p> <p>dI S 28</p>	<p>Enable</p> <p>AtV</p> <p>ENR 28</p>
<p>If equalization function is enabled in program 23, this program can be set up. If "Enable" is selected in this program, it's to activate battery equalization immediately and LCD main page will shows "EQ". If "Disable" is selected, it will cancel equalization function until next activated equalization time arrives based on program 27 setting. At this time, "EQ" will not be shown in LCD main page.</p>			

Display Information

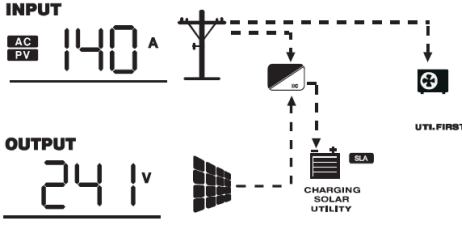
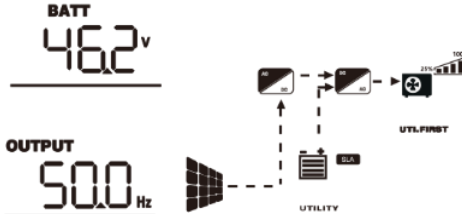
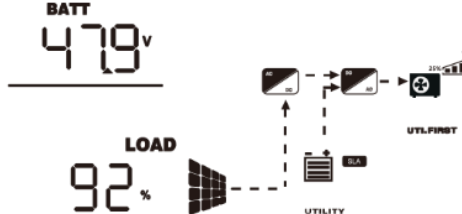
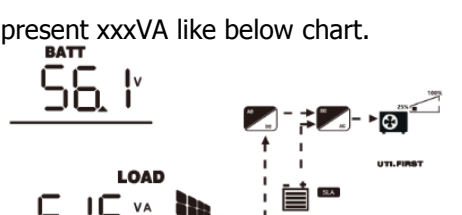
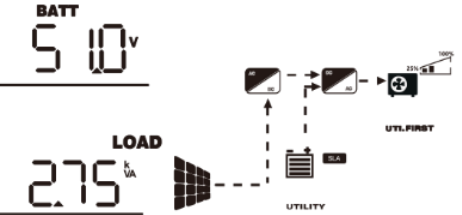
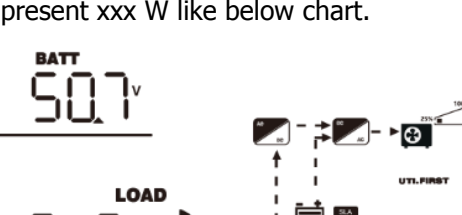

The LCD display information will be switched in turns by pressing "UP" or "DOWN" key. The selectable information is switched as below order: input voltage, input frequency, PV voltage, MPPT charging current, MPPT charging power, battery voltage, output voltage, output frequency, load percentage, load in VA, load in Watt, DC discharging current, main CPU Version and second CPU Version.

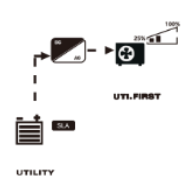
Setting Information	LCD display
Input voltage/ Output voltage (Default Display Screen)	<p>Input Voltage=230V, output voltage=230V</p>
Input frequency	<p>Input frequency=50Hz</p>
AC charging current	<p>AC charging current=30A</p>
PV voltage	<p>PV voltage=103V</p>
PV charging current	<p>PV charging current=50A</p>
PV charging power	<p>MPPT charging power=1.68KW</p>

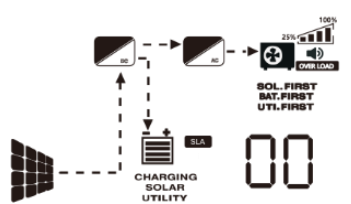
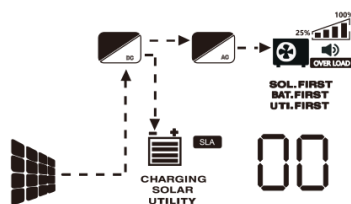
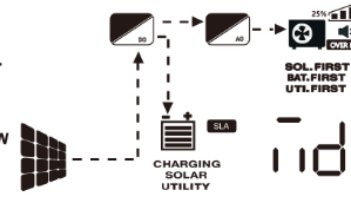
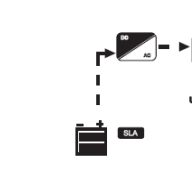
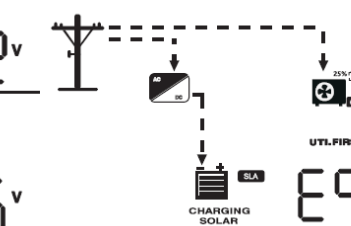



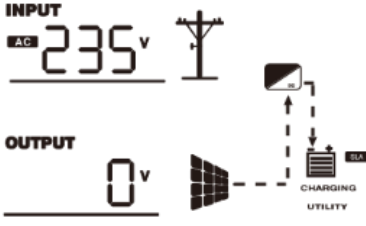
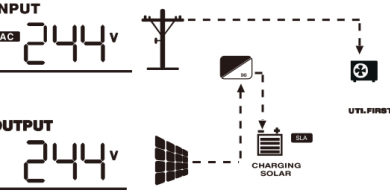
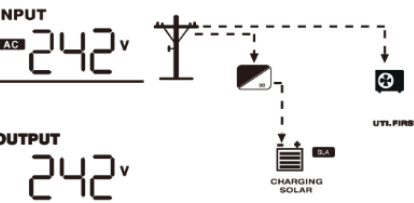
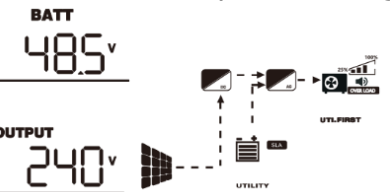



<p>PV and utility charging current</p>	<p>Current=140A</p> <p>INPUT AC PV 140 A</p> <p>OUTPUT 24 V</p> 
<p>Output frequency</p>	<p>Output frequency=50Hz</p> <p>BATT 46.2 V</p> <p>OUTPUT 50.0 Hz</p> 
<p>Load percentage</p>	<p>Load percent=92%</p> <p>BATT 47.9 V</p> <p>LOAD 92 %</p> 
<p>Load in VA</p>	<p>When connected load is lower than 1kVA, load in VA will present xxxVA like below chart.</p> <p>BATT 56.1 V</p> <p>LOAD 615 VA</p>  <p>When load is larger than 1kVA ($\geq 1kVA$), load in VA will present x.xkVA like below chart.</p> <p>BATT 51.0 V</p> <p>LOAD 2.75 kVA</p> 
<p>Load in Watt</p>	<p>When connected load is lower than 1kW, load in W will present xxx W like below chart.</p> <p>BATT 50.7 V</p> <p>LOAD 615 W</p> 

<p>Load in Watt</p>	<p>When load is larger than 1kW ($\geq 1\text{KW}$), load in W will present x.xkW like below chart.</p> <p>BATT 50.7^v</p> <p>LOAD 273^{KW}</p> 
<p>DC discharging current</p>	<p>DC discharging current=128A</p> <p>BATT 51.4^v</p> <p>BATT 128^A</p> 
<p>Main CPU version checking</p>	<p>Main CPU version 028-00-505</p> <p>028</p> <p>505</p> 
<p>Secondary CPU version checking</p>	<p>Secondary CPU version 029-00-409</p> <p>029</p> <p>409</p> 
<p>Inverter Rated Power</p>	<p>60^{KW}</p> 
<p>Battery level</p>	<p>Battery SOC=50%</p> <p>BATT 51.4^v</p> <p>BATT 50[%]</p> 
<p>Battery Equalization</p>	<p>BATT 58.2^v</p> <p>OUTPUT 225^v</p> 









Operating Mode Description

Operation mode	Description	LCD display
<p>Standby mode /Power saving mode</p> <p>Note:</p> <p>*Standby mode: The inverter is not turned on yet but at this time, the inverter can charge battery without AC output.</p>	<p>No output is supplied by PV still can charge batteries.</p>	<p>When utility grid connected, no charging; PV can charge</p> 
<p>Line Mode</p>	<p>Priority for utility drive the loading solar priority charging</p>	<p>Charging by PV energy</p> 
	<p>The unit will provide output power from the mains. It will also charge the battery at line mode.</p>	<p>Charging by utility</p> 
<p>Battery Mode</p>	<p>The unit will provide output power from battery and PV power.</p>	<p>Power from battery and PV energy.</p> 
	<p>The unit will provide output power from battery only.</p>	<p>Power from battery only.</p> 

Fault Reference Code

Fault Code	Fault Event	Icon on
01	Fan is not working.	
02	Over temperature	
03	Battery voltage is too high	
05	Output short circuited	
06	Output voltage is abnormal. Output voltage is too high.	
07	Overload time out	
20	BMS communication loss	
51	Over current or surge	

Warning Indicator

Warning Code	Warning Event	Audible Alarm	Icon flashing
01	MPPT PCB Fan Abnormal	Beep twice every second	
03	High Battery Voltage	Beep twice every second	
04	Battery low voltage/ Battery SOC low	Beep twice every second	
07	Overload In Inverter Mode	Beep twice every second	
12	Solar controller over temperature	Beep once every second	
51	Solar Charger Over Current	Beep once every second	
54	PV input over voltage	Beep once every second	
58	AC output low voltage	Beep once every second	

61	Sampling error of battery voltage detecting is over 0.5V	Beep once every second	
----	--	------------------------	---

Trouble Shooting

Problem	LCD/LED/Buzzer	Explanation / Possible cause	What to do
Unit shuts down automatically during startup process.	LCD/LEDs and buzzer will be active for 3 seconds and then complete off.	The battery voltage is too low (<1.91V/Cell)	1. Re-charge battery. 2. Replace battery.
No response after power on.	No indication.	1. The battery voltage is far too low. (<1.4V/Cell) 2. Battery polarity is connected reversed.	1. Check if batteries and the wiring are connected well. 2. Re-charge battery. 3. Replace battery.
Buzzer beeps continuously and red LED is on.	Fault code 01	Fan fault	Replace the fan.
	Fault code 02	Internal temperature of component is over 90°C.	Check if the air flow of the unit is blocked or the ambient temperature is too high.
	Fault code 03	Battery is over-charged.	Return to repair center.
		The battery voltage is too high.	Check if spec and quantity of batteries are meet requirements.
	Fault code 04	The battery voltage is too low.	
	Fault code 05	Output short circuited.	Check if wiring is connected well and remove abnormal load.
	Fault code 06/58	Output abnormal (Inverter voltage below than 180Vac or is higher than 290Vac)	1. Reduce the connected load. 2. Return to repair center
	Fault code 07	Overload error. The inverter is overload 110% and time is up.	Reduce the connected load by switching off some equipment.
	Fault code 20	BMS communication failed	1. Check the BMS communication wire to see if it's well connected 2. Check the transceiver signal
Fault code 51	Over current or surge	Restart the unit, if the error happens again, please return to repair center.	

Specifications

MODEL	SPF 4KT HVM	SPF 5KT HVM	SPF 6KT HVM	SPF 8KT HVM	SPF 10KT HVM	SPF 12KT HVM
Battery voltage	48VDC	48VDC	48VDC	48VDC	48VDC	48VDC
INVERTER OUTPUT						
Rated Power	4KW	5KW	6KW	8KW	10KW	12KW
Surge Rating (20ms)	12KW	15KW	18KW	24KW	30KW	36KW
Waveform	Pure sine wave/ same as input (bypass mode)					
Nominal Output Voltage	208V-220V-230V-240Vac(+/-10% RMS)					
Output Frequency	50Hz/60Hz (+/-0.3 Hz)					
Inverter Efficiency(Peak)	>85%					
Line Mode Efficiency	>95%					
Power Factor	1.0					
SOLAR CHARGER						
Maximum PV Charge Current	80A			120A		
DC Voltage	48V					
Maximum PV Array Power	5000W			7000W		
MPPT Operating Voltage(VDC)	60-145V					
Max. PV Array Open Circuit Voltage	150VDC					
Maximum Efficiency	>98%					
DC Input						
Low DC Cut-Off Voltage (Only Lead Acid)	Default @load<20%: 42.0V; @20%≤load<50%: 40.8V; @load≥50%: 38.4V (Based on Program 21, default 42.0V ,40Vdc~48Vdc settable)					
Low DC Warning Voltage (Only Lead Acid)	Low DC Cut-Off Voltage +2Vdc					
Low DC Warning Return Voltage (Only Lead Acid)	>48V					
Low DC Warning SOC (Only Li)	<Low DC Cut-off SOC +5%					
Low DC Warning Return SOC (Only Li)	>Low DC Cut-off SOC +15%					
Low DC Cut-off SOC (Only Li)	Default 20%, 5%~50% Settable					
Cold Start SOC (Only Li)	>Low DC Cut-off SOC+10%					
High DC Recovery Voltage	58VDC					
High DC Cut-Off Voltage	AGM:60V, FLD:62V, USE or Li Mode: C.V. Voltage + 4.0V					
AC INPUT						
Voltage	230VAC					
Selectable Voltage Range	154~272VAC(for appliances), 184~272VAC(for UPS)					
Frequency Range	50Hz/60Hz (Auto sensing)					
Maximum Charge Current	40A	50A	60A	70A	80A	100A
BYPASS & PROTECTION (Grid & Generator)						
Typical Transfer Time	10ms					
Overload Protection (SMPS Load)	Circuit breaker					

Output Short Circuit Protection	Circuit breaker					
MECHANICAL SPECIFICATIONS						
Dimensions (W*H*D)	540*360*218mm			650*380*225mm		
Net Weight (kg)	38	41	45	64	66	75
Gross Weight (kg)	43	45	50	84	86	94
OPERATING ENVIRONMENT						
Operation Temperature Range	0°C to 50°C					
Storage Temperature	-20°C to 60°C					